

REV. I	REV. II	ÄNDRINGEN	REVISOR	DATE
01	0744	Ändrad inkoppling till K4, K15, K16, K19 samt plintar 8, 12, 13, 15		TLN
02	0751	K21 och K22 tillkommit		TLN
03	0803	K212 & K222 ändrade till K214 & K224		TLN
04	0808	Ändrad inkoppling till K19-2		TLN
05	0810	Tidrelä K15 & K16 samt relä K21 & K22 borttagna		TLN

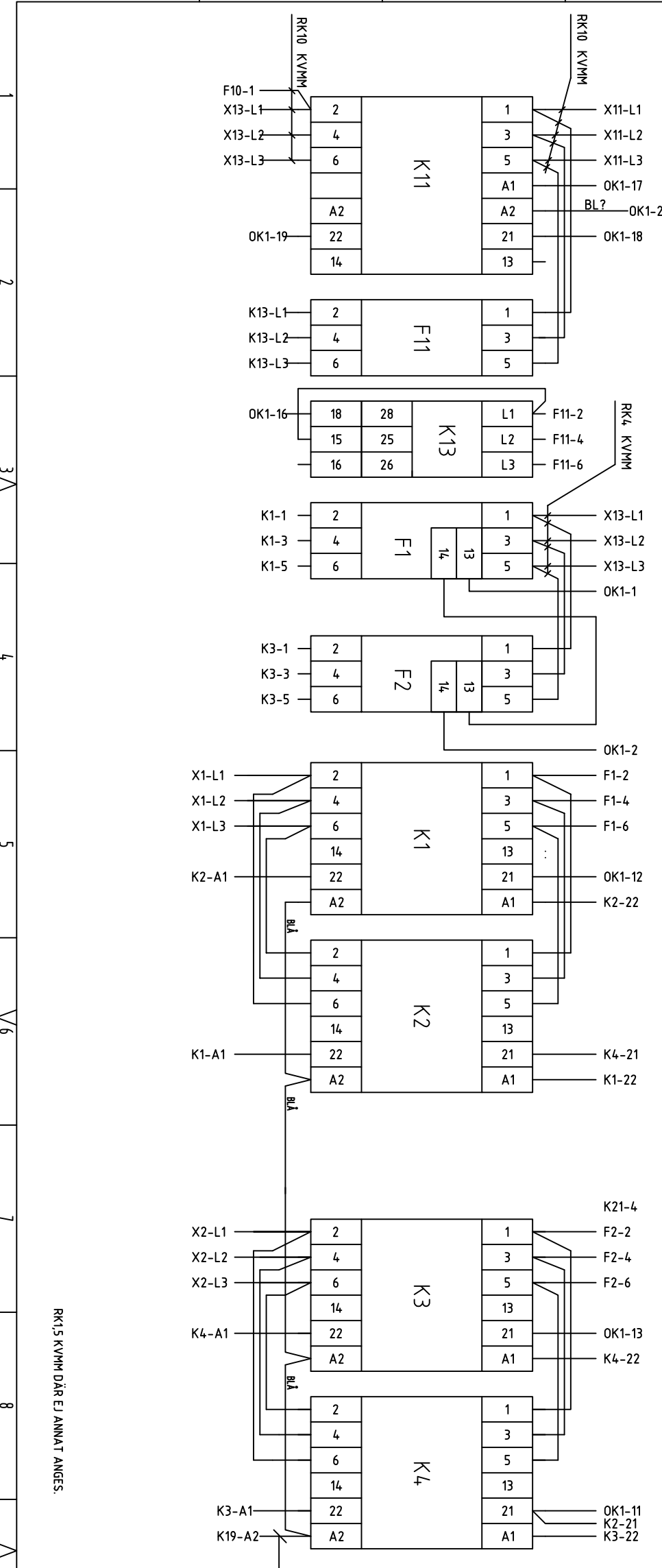

RK15 KVMM DÄR EJ ANNAT ANGES.

APPARATSKÅP OK1

ART	A1	BEHÅLLNING	KIND	REVISOR	DATE
TLN	0726				

KOPPLINGSCHEMA CHASSI B

MPW6-731300

01 05

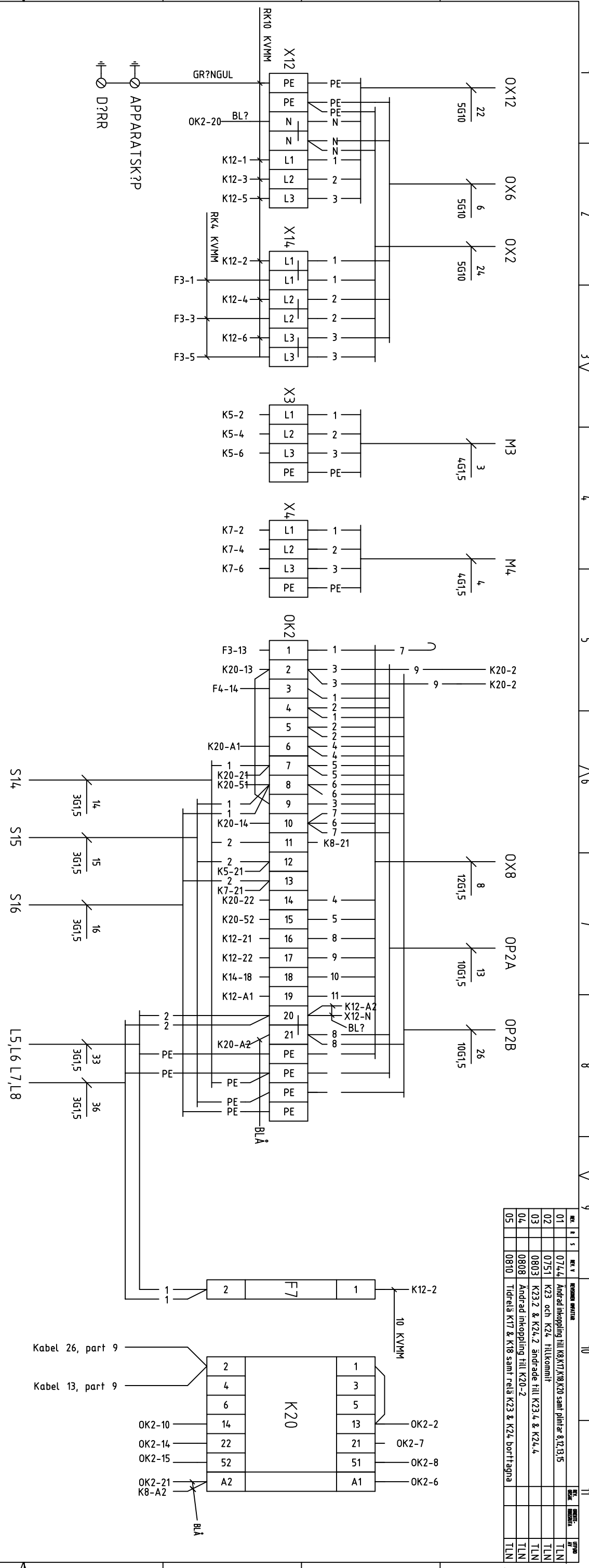

NO	REVISION	ÄNDRING	ANMÄRKNING
01	0714	Ändrad inkoppling till K8/K17/K18/K20 samt plintar 8,12,13,15	TLN
02	0751	K23 och K24 - filtkommit	TLN
03	0803	K23.2 & K24.2 ändrade till K23.4 & K24.4	TLN
04	0808	Ändrad inkoppling till K20-2	TLN
05	0810	Tidrelä K17 & K18 samt relä K23 & K24 borttagna	TLN

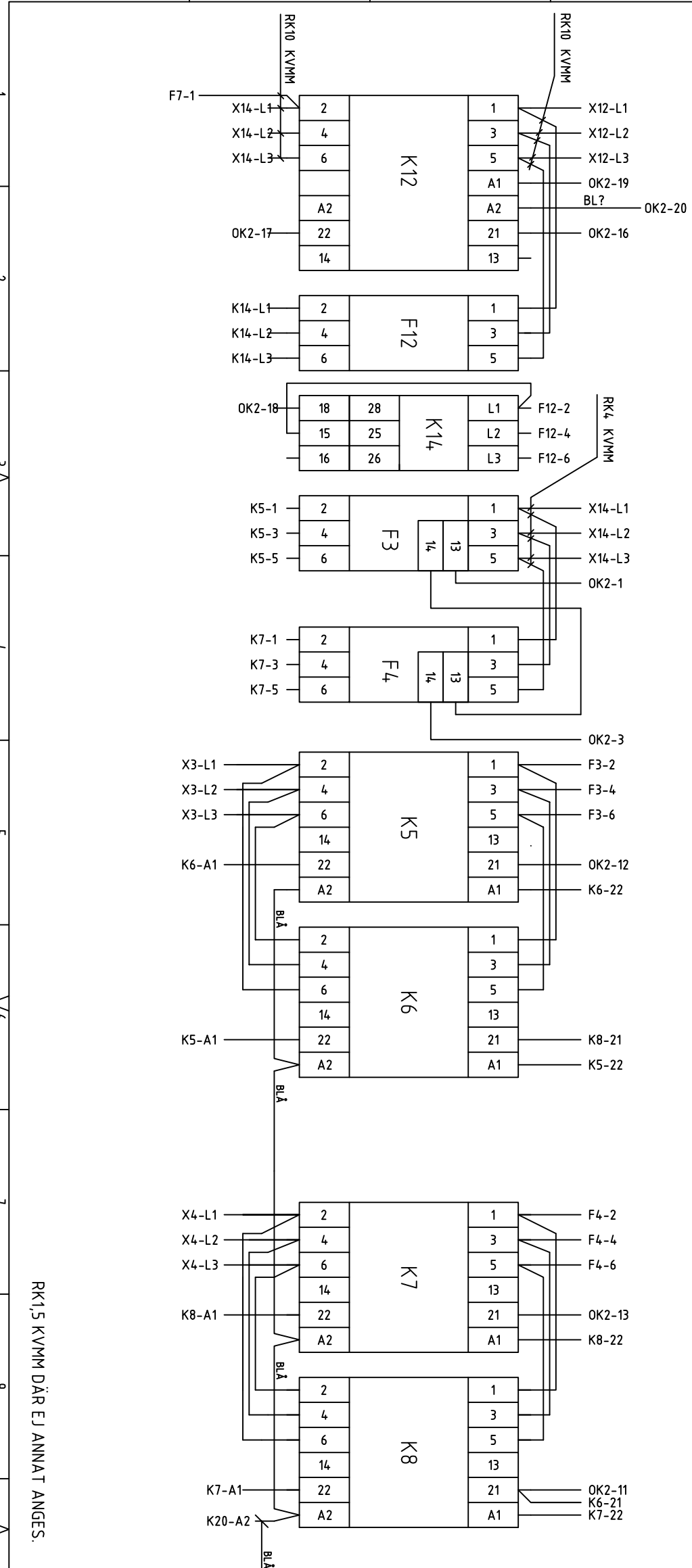

APPARATSKÅP OK2

NO	REVISION	ÄNDRING	ANMÄRKNING
A1	KIND	KOPPLINGSSCHEMA CHASSI A	02
TLN	0726	MPW6-731300	05

RK1,5 KVMM DÄR EJ ANNAT ANGES.

CHASSI B

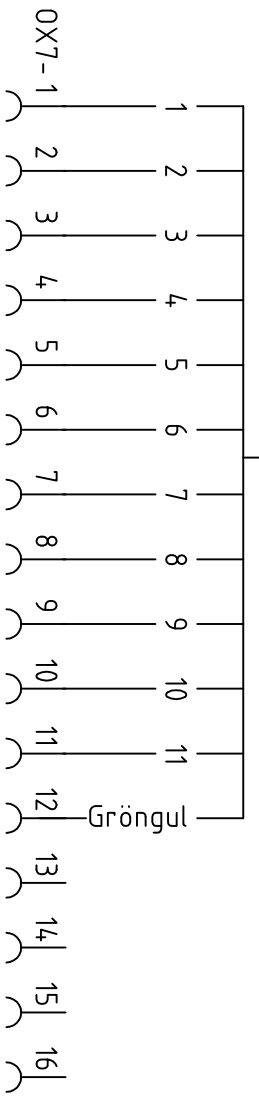
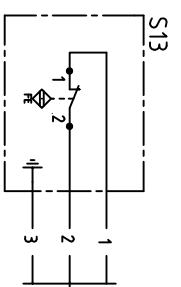
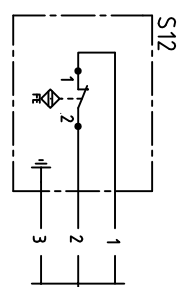
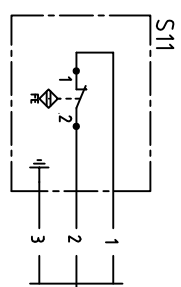
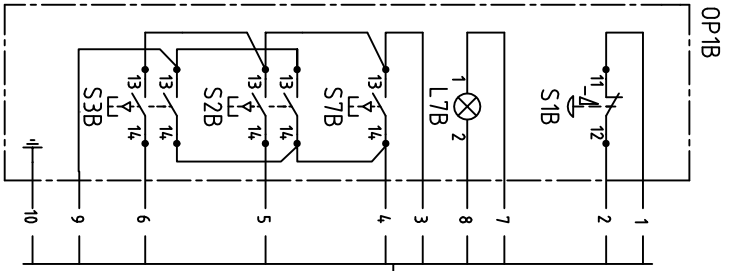
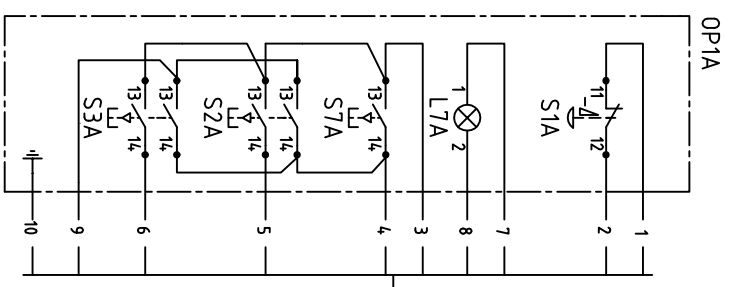

CHASSI A

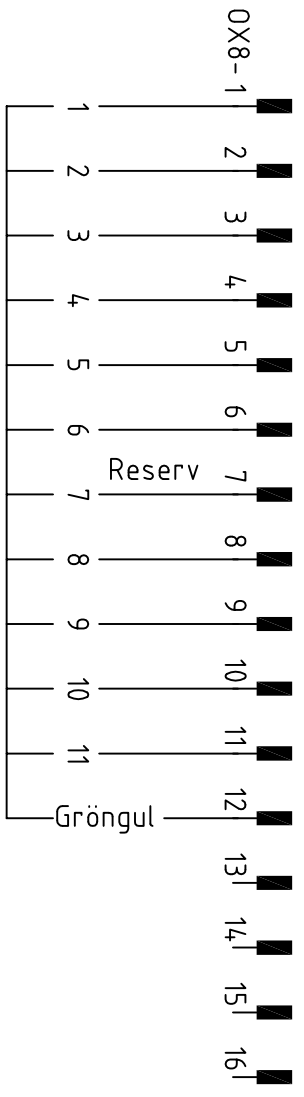
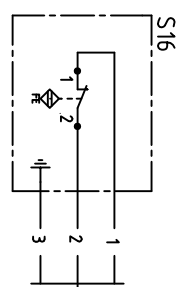
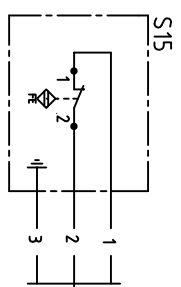
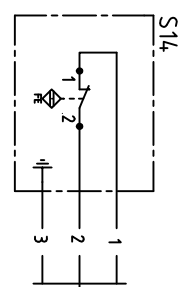
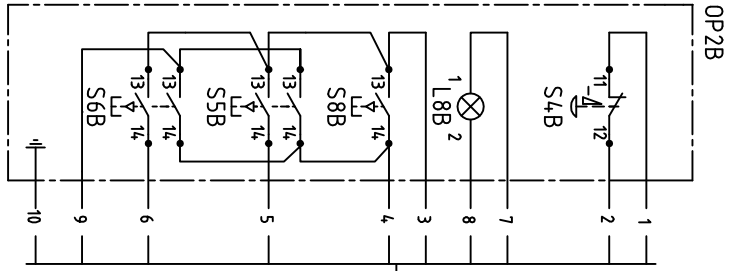
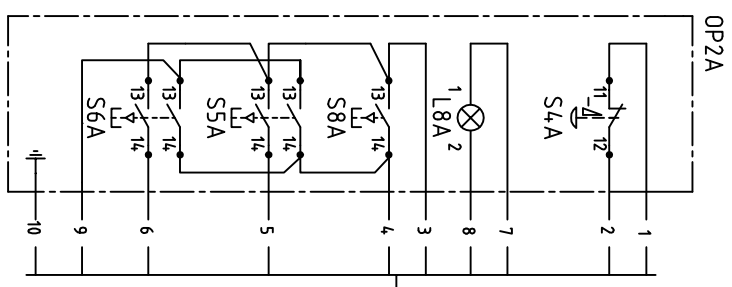

OPERATÖRSPANELER, GRÄNSLÄGEN OCH 16-POL KONTAKTIDON

ARTID	KIND	BEHÅLLNING
A1		KOPPLINGSSCHEMA CHASSI B OCH A
SKALA	UTGÅVA NR	REVISJON
TLN 0733	0733	MPW6-731300
		03
		01